

ASSEMBLY INSTRUCTIONS - DOUBLE BED

LIST OF PARTS

Ax1 Headboard

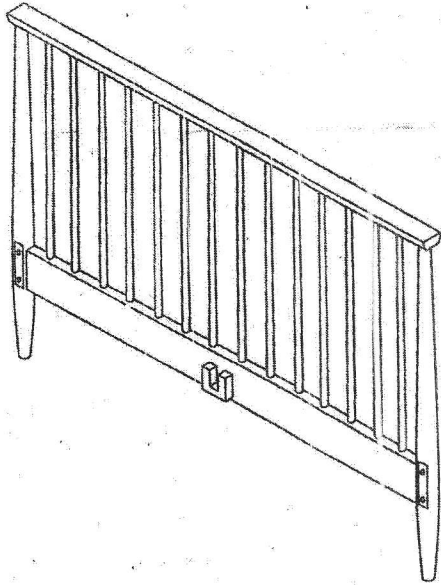

Bx1 Footboard

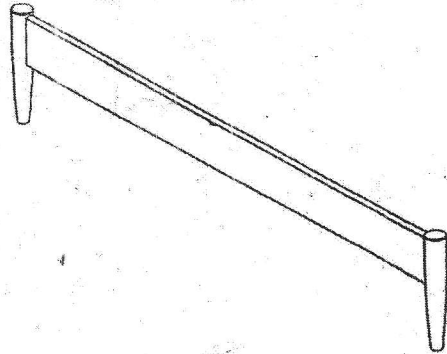

Cx2 Side Rail

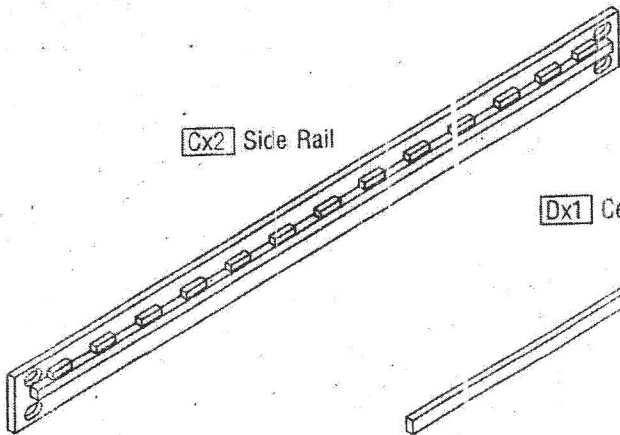

Dx1 Center Rail

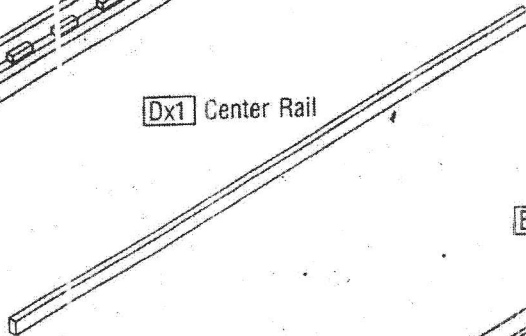

Ex14 Slats

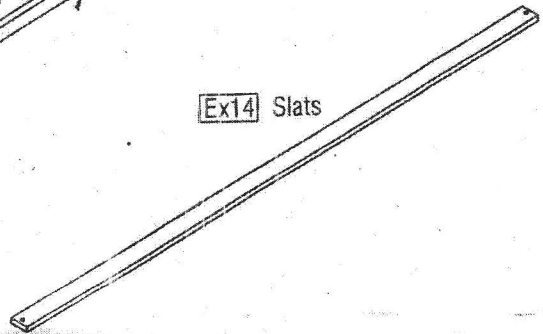

HARDWARE

1 Bolts - M8x50

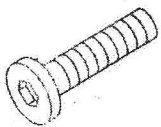

8pcs

2



8pcs

3 Screw - 4x30

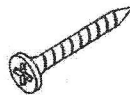

28pcs

4 Allen key - M4



1pc

Step 1

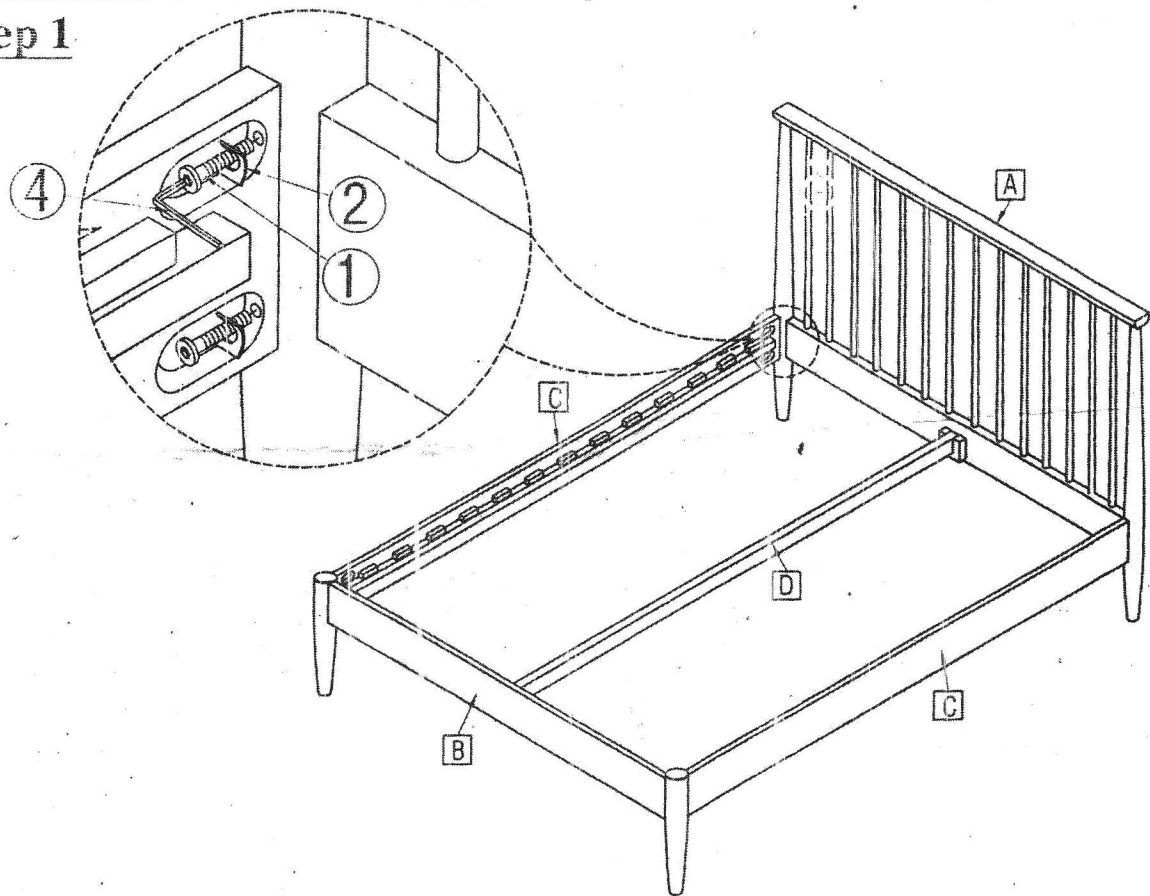

Step 2

