

# ASSEMBLY INSTRUCTIONS - KING BED

## LIST OF PARTS

Headboard

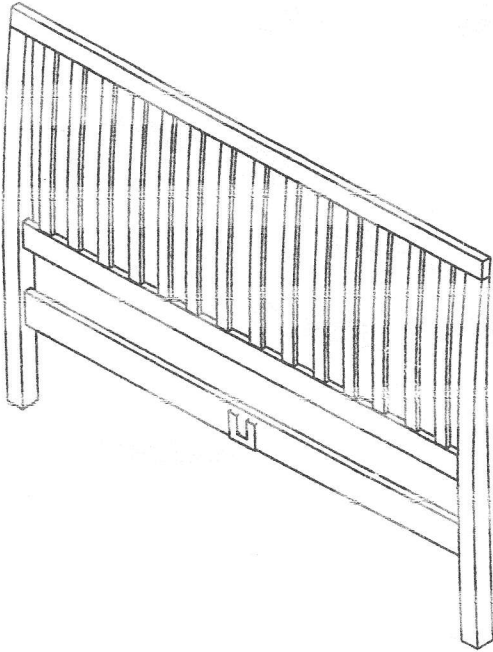

Bx1 Footboard

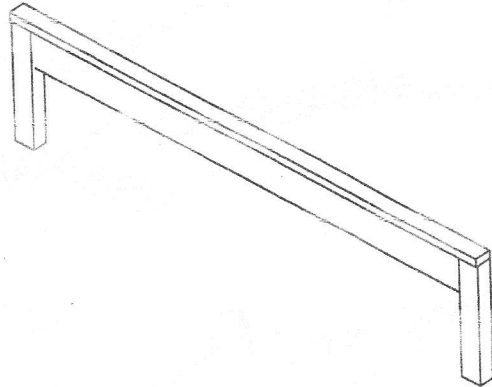

Cx2 Side Rail

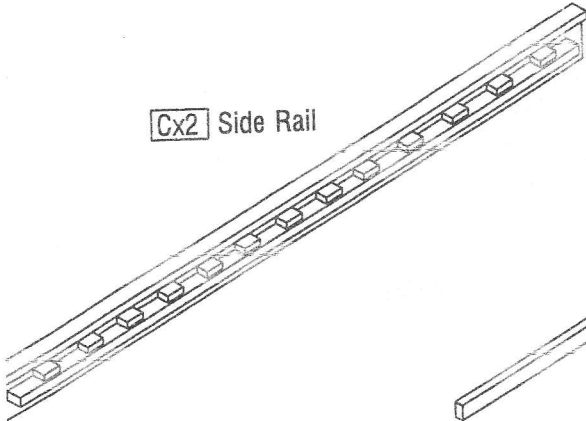

Dx1 Center Rail

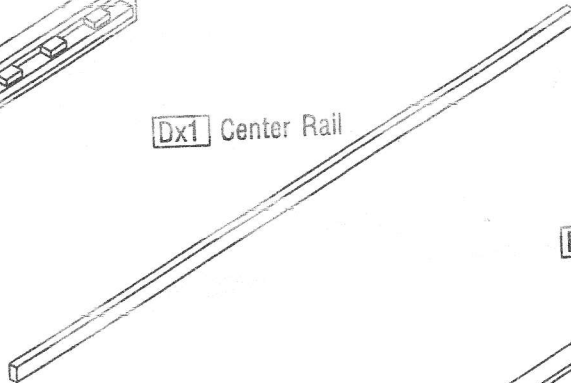

Ex15 Slats

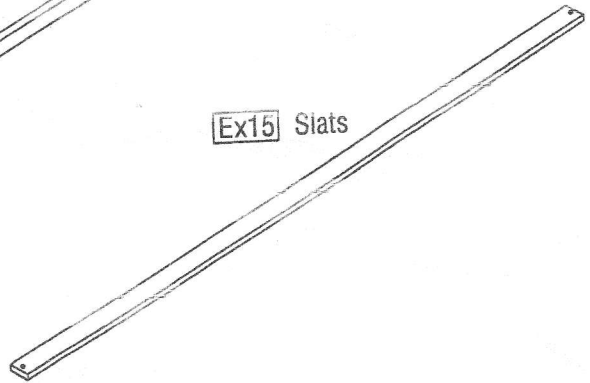

## HARDWARE

Bolts - M6x12

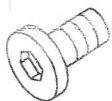

8 pcs

2 Screw - 4x30

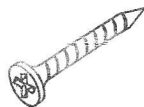

30 pcs

3 Allen key - M4



1 pc

# Step 1

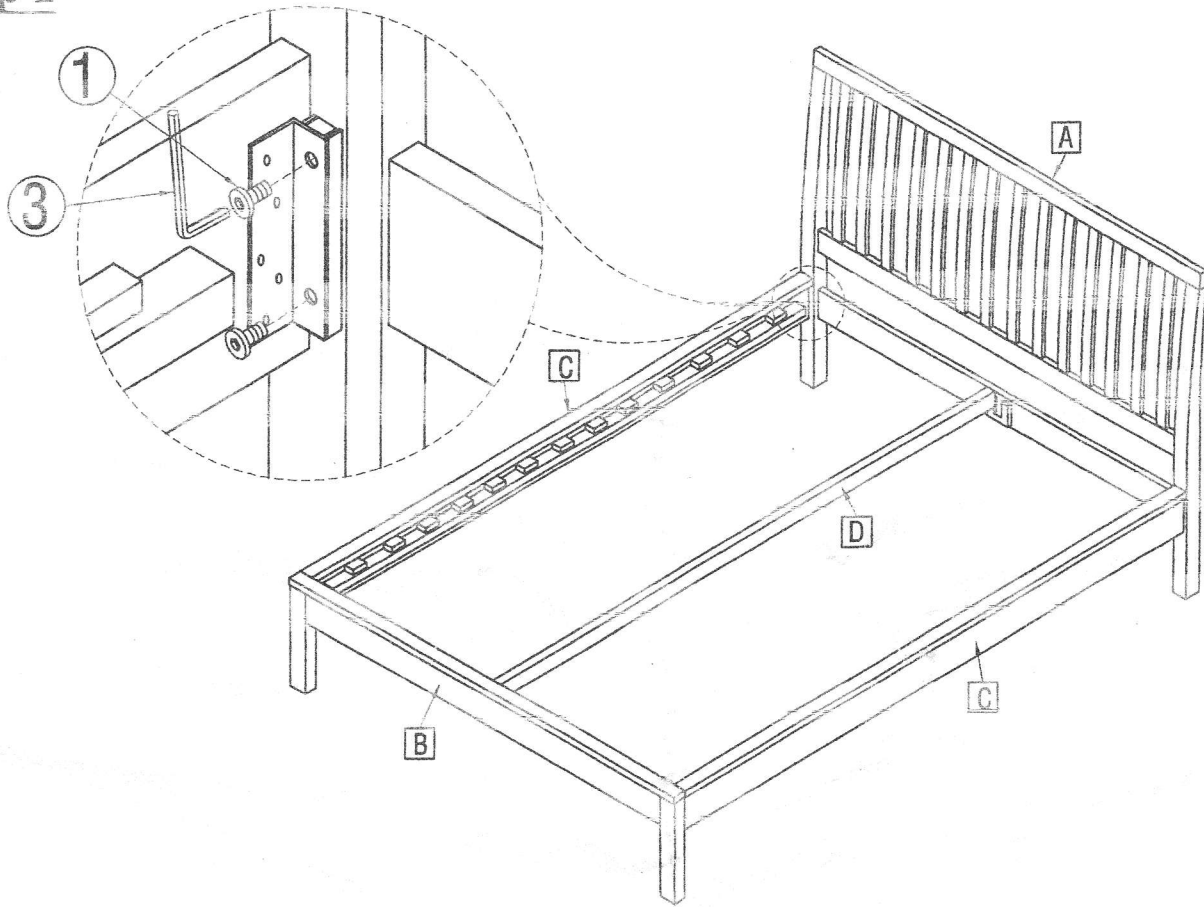

# Step 2

